

# 3M™ I/O Connector Mounting Options and Hardware

## Hardware Guide

Date Modified: January 14, 2008

Mounting Hardware Applications - Table 1

Part Number	Type	Mini D Ribbon (MDR) Conn.'s	D Sub Conn.'s	D Ribbon Conn.'s	Shrunk D Ribbon (SDR) Conn.'s	Sheet #	RIA Code
*3341-1L	Jack Socket Screw		X	X		2 of 9	RIA E5 & C3 apply
*3341-1S	Jack Socket Screw		X	X			
*3341-2	Jack Socket Screw			X			
*3341-3	Jack Socket Screw			X			
*3341-4	Jack Socket Screw		X	X			
*3341-10	Jack Socket Screw	X				3 of 9	
*3341-13	Jack Socket Screw	X					
*3341-16	Jack Socket Screw	X					
*3341-17	Jack Socket Screw	X					
*3341-25	Jack Socket Screw	X					
*3341-30	Jack Socket Screw	X				4 of 9	
*3341-31	Jack Socket Screw	X					
*3341-32	Jack Socket Screw	X					
*3341-35	Jack Socket Screw	X					
*3341-36	Jack Socket Screw	X					
*3342-1	Jack Screw Kits		X			5 of 9	
*3342-2	Jack Screw Kits		X				
*3342-3	Jack Screw Kits		X	X			
*3342-4	Jack Screw Kits		X	X			
3344-3	Board Lock Screw	X				6 of 9	
3344-4	Board Lock Screw	X					
3344-26	Panel Mount Screw	X					
3344-38	Panel Mount Screw	X					
3344-44	Panel Mount Screw	X					
3475-1	Bail Mount Kits			X		7 of 9	
3475-4	Bail Mount Kits			X			
3475-5	Bail Mount Kits			X			
12600-S-08	Jack Socket Screw				X	8 of 9	
12600-S-10	Jack Socket Screw				X		
12600-S-12	Jack Socket Screw				X		
12600-S-M2X55	Board Lock Screw				X		
Mounting hardware Guide			X			9 of 9	

-See sheet 7 of 9 for D Ribbon & Plastic Connector accessories.-

Notes:

1. Use Table 1 as a guide for selecting the correct mounting hardware.
2. See sheet 9 of 9 for selection guide - 9 to 37 and 50 position D Sub connectors.
3. See Regulatory Information Appendix (RIA) for chemical compliance information.

TS-0142-E  
Sheet 1 of 9

# 3M™ I/O Connector Mounting Options and Hardware

## Jacket Socket Screws

**3M Part Number**  
**3341-1L**

Kit Contents:  
2 - Jack Sockets  
4 - Spacers .031 [0.79] Thick  
2 - Lock Washers  
2 - 4-40 Nuts

Material: Steel  
Finish: Zinc with Clear Chromate  
Screw / Socket Thread Size: #4-40 / #4-40  
Recommended Max. Torque: 7.0 inch-lbf [0.8 N·m]  
Quantity: See Kit Contents

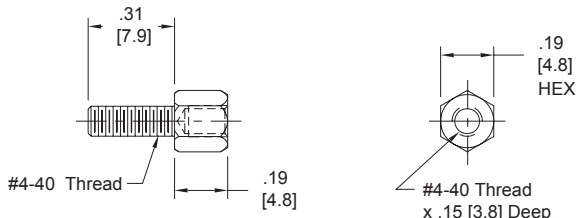

**3M Part Number**  
**3341-1S**

Kit Contents:  
2 - Jack Sockets  
4 - Spacers .031 [0.79] Thick  
2 - Lock Washers  
2 - 4-40 Nuts

Material: Steel  
Finish: Zinc with Clear Chromate  
Screw / Socket Thread Size: #4-40 / #4-40  
Recommended Max. Torque: 7.0 inch-lbf [0.8 N·m]  
Quantity: See Kit Contents

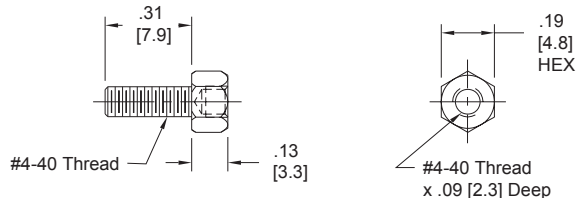

**3M Part Number**  
**3341-2**

Kit Contents:  
2 - Jack Sockets  
2 - Lock Washers  
2 - 4-40 Nuts

Material: Steel  
Finish: Zinc with Clear Chromate  
Screw / Socket Thread Size: #4-40 / #4-40  
Recommended Max. Torque: 7.0 inch-lbf [0.8 N·m]  
Quantity: See Kit Contents

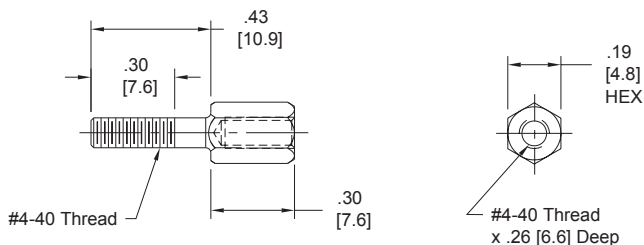

**3M Part Number**  
**3341-3**  
**IEEE-488-Type**

Kit Contents:  
2 - Jack Sockets  
4 - Spacers .031 [0.79] Thick  
2 - Lock Washers  
2 - 4-40 Nuts

Material: Steel  
Finish: Black Oxide  
Screw / Socket Thread Size: #4-40 / M3.5  
Recommended Max. Torque: 7.0 inch-lbf [0.8 N·m]  
Quantity: See Kit Contents

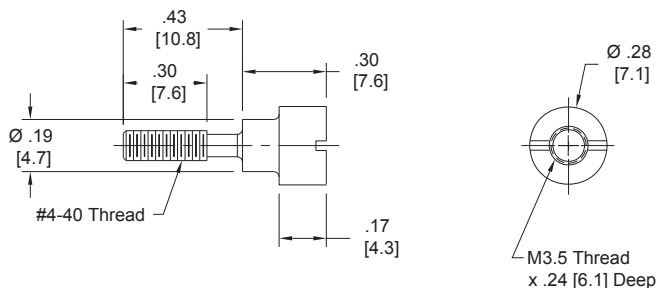

**3M Part Number**  
**3341-4**

Kit Contents:  
2 - Jack Sockets  
4 - Spacers .031 [0.79] Thick  
2 - Lock Washers  
2 - 4-40 Nuts

Material: Steel  
Finish: Zinc with Clear Chromate  
Screw / Socket Thread Size: #4-40 / #4-40  
Recommended Max. Torque: 7.0 inch-lbf [0.8 N·m]  
Quantity: See Kit Contents

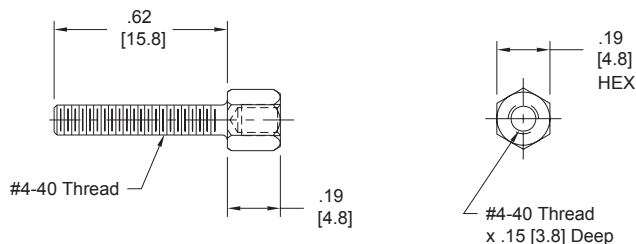

# 3M™ I/O Connector Mounting Options and Hardware

**3M Part Number**  
**3341-10**

Material: Stainless Steel  
Screw / Socket Thread Size: M2.5 / M2.5  
Recommended Max. Torque: 2.5 inch-lbf [0.3 N-m]  
Package Size: 200 Pieces

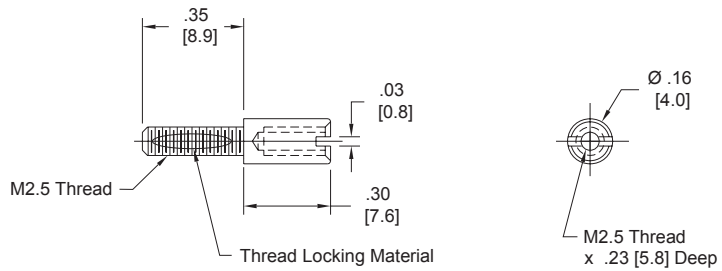

**3M Part Number**  
**3341-13**

Material: Stainless Steel  
Screw / Socket Thread Size: M2.5 / #4-40  
Recommended Max. Torque: 2.5 inch-lbf [0.3 N-m]  
Package Size: 200 Pieces

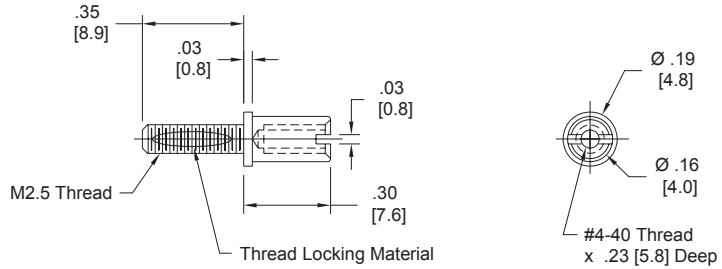

**3M Part Number**  
**3341-16**

Material: Stainless Steel  
Screw / Socket Thread Size: #4-40 / #4-40  
Recommended Max. Torque: 3.5 inch-lbf [0.4 N-m]  
Package Size: 200 Pieces

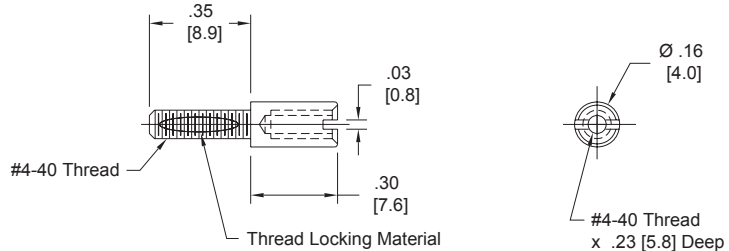

**3M Part Number**  
**3341-17**

Material: Stainless Steel  
Screw / Socket Thread Size: #4-40 / #4-40  
Recommended Max. Torque: 3.5 inch-lbf [0.4 N-m]  
Package Size: 200 Pieces

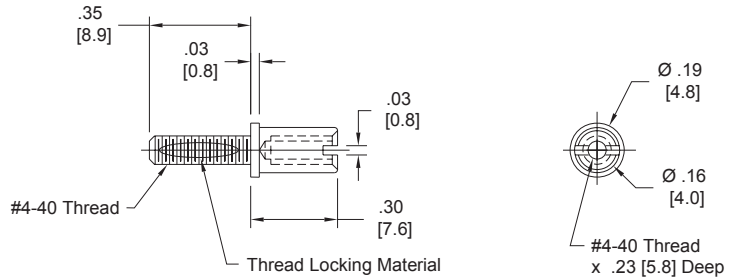

**3M Part Number**  
**3341-25**

Material: Stainless Steel  
Screw / Socket Thread Size: M2.5 / M2  
Recommended Max. Torque: 2.5 inch-lbf [0.3 N-m]  
Package Size: 200 Pieces

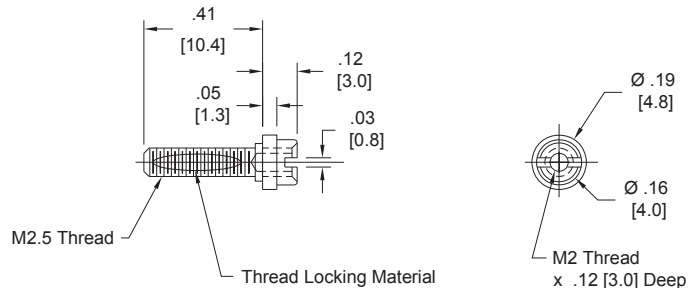

# 3M™ I/O Connector Mounting Options and Hardware

**3M Part Number**  
**3341-30**

Material: Stainless Steel  
Screw / Socket Thread Size: #4-40 / #4-40  
Recommended Max. Torque: 3.5 inch-lbf [0.4 N-m]  
Package Size: 200 Pieces

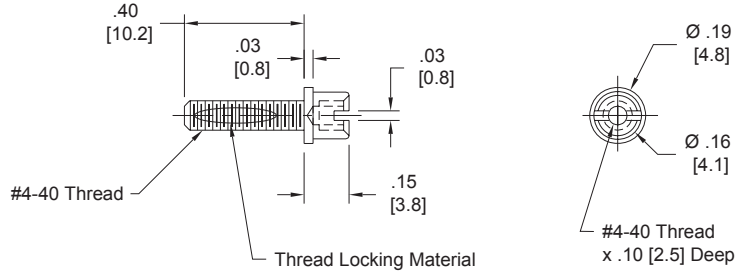

**3M Part Number**  
**3341-31**

Material: Stainless Steel  
Screw / Socket Thread Size: M2.5 / #4-40  
Recommended Max. Torque: 2.5 inch-lbf [0.3 N-m]  
Package Size: 200 Pieces

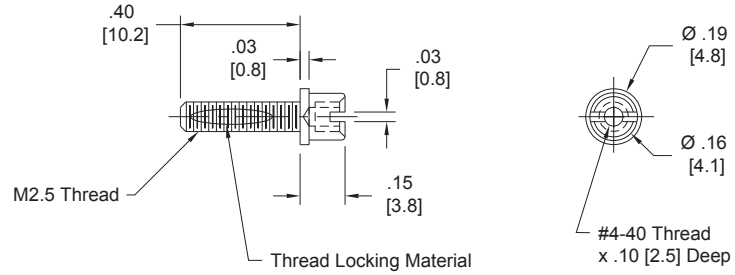

**3M Part Number**  
**3341-32**

Material: Stainless Steel  
Screw / Socket Thread Size: M2.5 / #4-40  
Recommended Max. Torque: 2.5 inch-lbf [0.3 N-m]  
Package Size: 200 Pieces

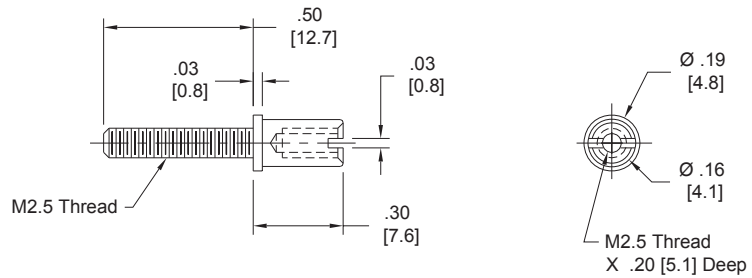

**3M Part Number**  
**3341-35**

Material: Stainless Steel  
Screw / Socket Thread Size: M2.5 / #4-40  
Recommended Max. Torque: 2.5 inch-lbf [0.3 N-m]  
Package Size: 200 Pieces

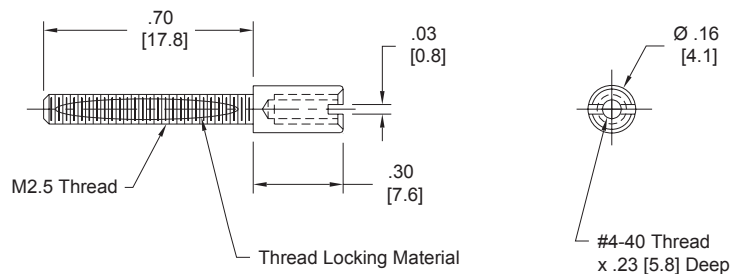

**3M Part Number**  
**3341-36**

Material: Stainless Steel  
Screw / Socket Thread Size: M2.5 / M2.5  
Recommended Max. Torque: 2.5 inch-lbf [0.3 N-m]  
Package Size: 200 Pieces

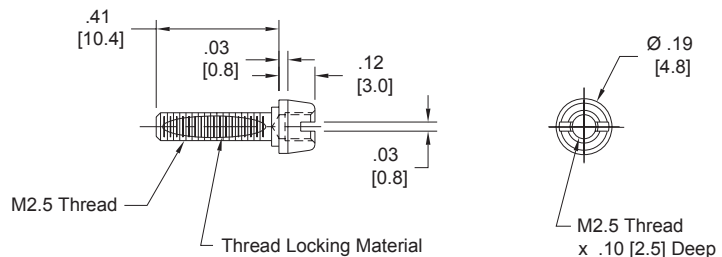

# 3M™ I/O Connector Mounting Options and Hardware

## JackScrew Kits

### 3M Part Number 3342-1

Material: Steel  
 Finish: Zinc with Clear Chromate  
 Thread size: #4-40  
 Recommended Max. Torque: 7.0 inch-lbf [0.8 N-m]  
 Package Size: 2 Each

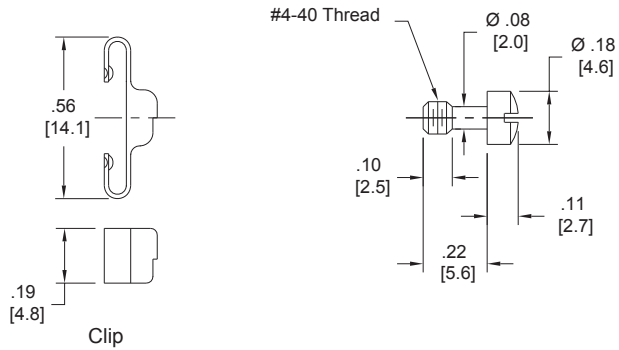

### 3M Part Number 3342-2

Material: Steel  
 Finish: Zinc with Clear Chromate  
 Thread size: #4-40  
 Recommended Max. Torque: 7.0 inch-lbf [0.8 N-m]  
 Package Size: 2 Each

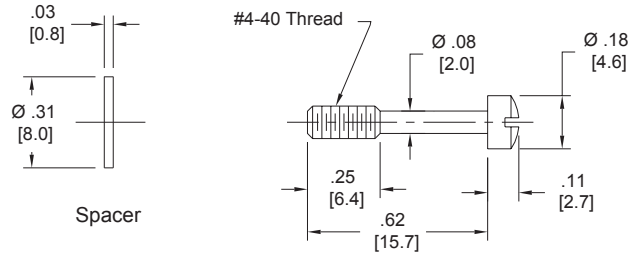

### 3M Part Number 3342-3

Material: Steel  
 Finish: Zinc with Clear Chromate  
 Thread size: #4-40  
 Recommended Max. Torque: 7.0 inch-lbf [0.8 N-m]  
 Package Size: 2 Each

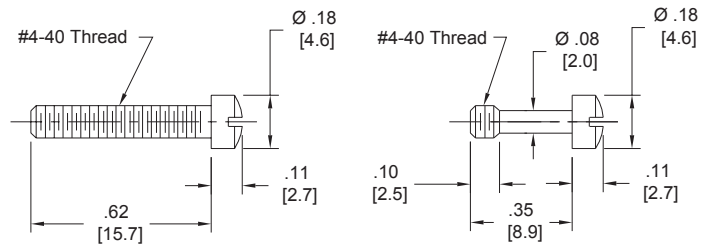

### 3M Part Number 3342-4

Material: Steel  
 Finish: Zinc with Clear Chromate  
 Thread size: #4-40  
 Recommended Max. Torque: 7.0 inch-lbf [0.8 N-m]  
 Package Size: 2 Each

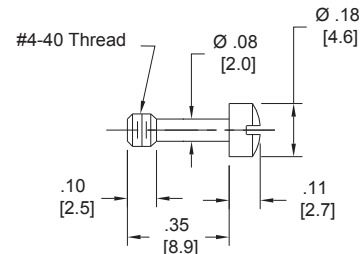

TS-0142-E  
 Sheet 5 of 9

# 3M™ I/O Connector Mounting Options and Hardware

## Board Lock Screws

Use to attach connector to printed circuit board. Not for use for panel mounting.

### 3M Part Number 3344-3

Material: Steel  
Finish: Nickel Plated  
Thread size: M2.5  
Recommended Max. Torque: 2.5 inch-lbf [0.3 N-m]  
Package Size: 200 Pieces

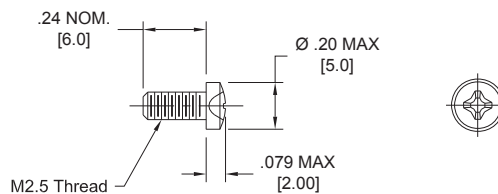

### 3M Part Number 3344-4

Material: Steel  
Finish: Nickel Plated  
Thread size: #4-40  
Recommended Max. Torque: 3.5 inch-lbf [0.4 N-m]  
Package Size: 200 Pieces

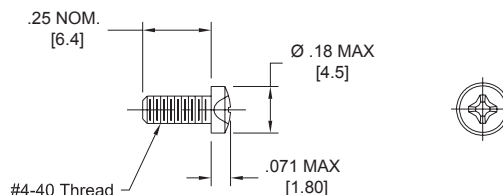

### 3M Part Number 3344-26

Material: Steel  
Finish: Zinc  
Thread size: M2.6  
Recommended Max. Torque: 2.5 inch-lbf [0.3 N-m]  
Package Size: 200 Pieces

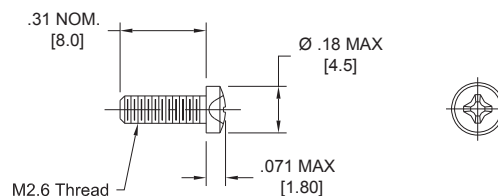

### 3M Part Number 3344-36

Material: Steel  
Finish: Zinc  
Thread size: M2.5  
Recommended Max. Torque: 2.5 inch-lbf [0.3 N-m]  
Package Size: 200 Pieces

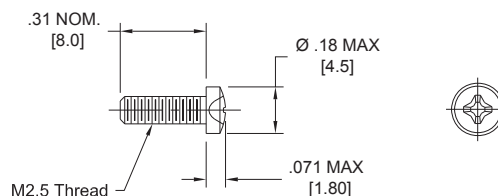

### 3M Part Number 3344-44

Material: Steel  
Finish: Zinc  
Thread size: #4-40  
Recommended Max. Torque: 3.5 inch-lbf [0.4 N-m]  
Package Size: 200 Pieces

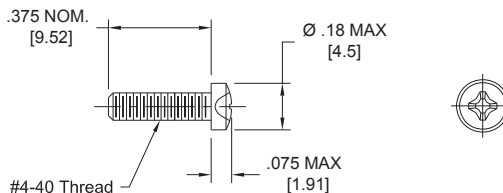

TS-0142-E  
Sheet 6 of 9



# 3M™ I/O Connector Mounting Options and Hardware

## Bail Mount Kits for D Ribbon Connectors

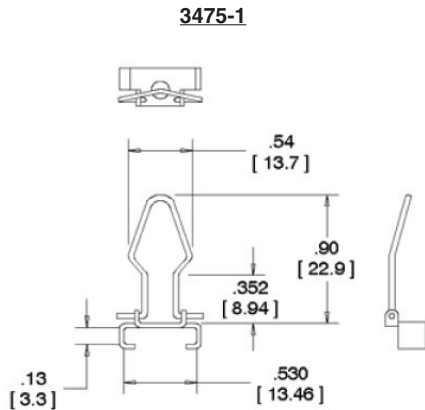

Plastic Connector  
Mounted to Front of Panel

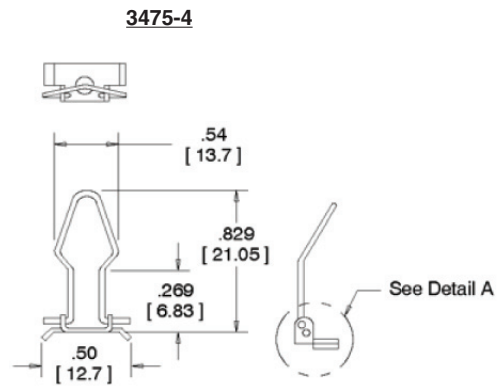

Plastic & Metal Faced Connectors  
Mounted to Rear of  
.0625, .075, .125 Panels

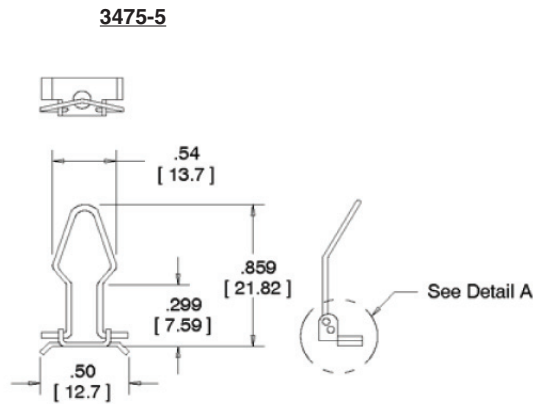

Plastic & Metal Faced Connectors  
Mounted to Rear of  
.035, .042, .094 Panels

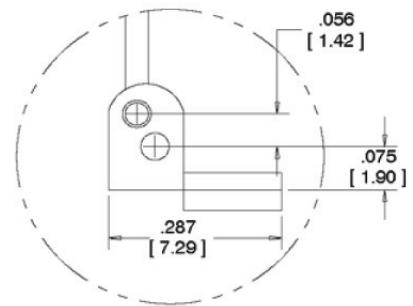

Kits Contain 2 ea.  
Ball Assy.  
Screw - 4-40 x .50. RND HD SLTD  
Nut - #4-40 UNC  
Washer - Lock-split

Contact Quantity	Mating Connectors		Junction Shell	Strain Relief	Pull-Tab
	Plug	Socket	Plastic		
14	3572-100X	3573-100X	3485-1800Y	3448-60	3490-2
24	3548-100X	3549-100X	3485-1700Y	3448-61	3490-2
36	3366-100X	3367-100X	3485-2800Y	3448-62	3490-3
50	3564-100X	3565-100X	3485-2500Y	3448-63	3490-5

Options:  
X = mounting style  
Y = "F" for flat cable, "R" for round cable

Inch [mm]		
Tolerance Unless Noted		
	.0	.00
Inch	±.1	±.01
		±.005

[ ] Dimensions for Reference only

TS-0142-E  
Sheet 7 of 9

# 3M™ I/O Connector Mounting Options and Hardware

## Jack Socket Screws

Use to attach connector to panel or chassis. Not for use for PC board mounting.

### 3M Part Number 12600-S-08

For .03" [0.8 mm] Panel Thickness

Material: Steel  
Finish: Nickel Plated  
Screw / Socket Thread Size: M2 / M2  
Recommended Max. Torque: 2.5 inch-lbf [0.3 N-m]  
Package Size: 200 Pieces

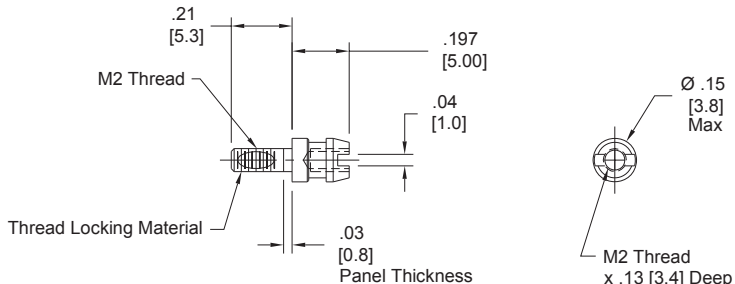

### 3M Part Number 12600-S-10

For .04" [1.0 mm] Panel Thickness

Material: Steel  
Finish: Nickel Plated  
Screw / Socket Thread Size: M2 / M2  
Recommended Max. Torque: 2.5 inch-lbf [0.3 N-m]  
Package Size: 200 Pieces

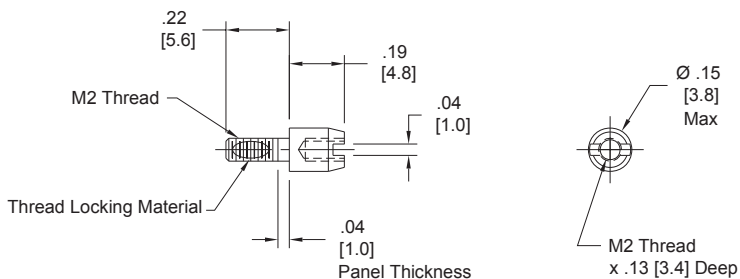

### 3M Part Number 12600-S-12

For .05" [1.2 mm] Panel Thickness

Material: Steel  
Finish: Nickel Plated  
Screw / Socket Thread Size: M2 / M2  
Recommended Max. Torque: 2.5 inch-lbf [0.3 N-m]  
Package Size: 200 Pieces

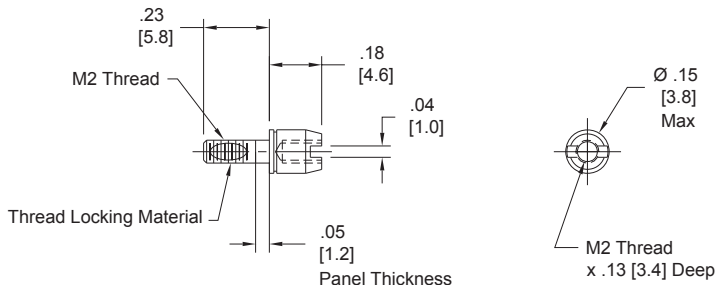

## Board Lock Screw

Use to attach connector to printed circuit board. Not for use for panel mounting.

### 3M Part Number 12600-S-M2x55

Material: Steel  
Finish: Zinc  
Thread size: M2  
Recommended Max. Torque: 2.5 inch-lbf [0.3 N-m]  
Package Size: 600 Pieces

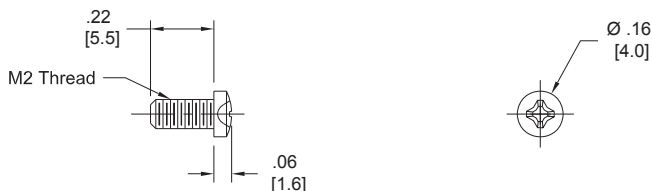

TS-0142-E  
Sheet 8 of 9





# 3M™ I/O Connector Mounting Options and Hardware

## D Sub Connectors

### Mounting Hardware Guide

#### Selection Guide - 9 to 37 Position D Sub Connectors

1. To mount a connector to a panel, select the correct Jack Socket Kit from table 1.
2. To secure a mating connector to a panel mounted connector, select the correct Jack Screw Kit from table 2.
3. To secure two connectors together in a mid-span application where no panel exists, select both the Jack Socket Kit and Jack Screw Kit from table 2.

Panel Thickness	Front Mount		Rear Mount	
	Kit	Spacers	Kit	Spacers
1/16	3341-1L	2	3341-1L	0
3/32	3341-1L	2	3341-1S	1
1/8	3341-4	2	3341-1S	0

Note: Spacers Placed Under Head of Jack Sockets

Junction Shell	Jack Screw		Jack Socket
	Kit	Spacers	Kit
-----	3342-1	-----	3341-1L
3485-2X00	3342-2	2	3341-4
3357-41XX	3342-2	2	3341-4
3357-51XX	3342-2	2	3341-4
3357-65XX	Supplied	-----	3341-4
3357-92XX	Supplied or 3341-7		3341-1L

Notes:

1. Jack Sockets used for MidSpan Applications.
2. Spacers Placed Under Head of Jack Screws.

#### Selection Guide - 50 Position D Sub Connectors

Mounting Options Using 3357-9250 Junction Shell & 3505-62 Latch Bracket

Front Panel Mounted Connectors:

Connectors not designed for this application

Rear Panel Mounted Connectors:

1/16" Panel: 1 Spacer Latch Bracket and Panel

3/32" Panel: No Spacers.

>3/32" Panel: Latch Bracket not designed for these applications.

Mid-Span Applications: Mount Latch Bracket directly to either the Plug or Socket Connector.

TS-0142-E  
Sheet 9 of 9



# Regulatory Information Appendix

## 3M Electronic Solutions Division/Interconnect

### EUROPE

#### Appendix E1: European Union RoHS

Directive 2002/95/EC, Restriction of the Use of Certain Hazardous Substances in Electrical & Electronic Equipment, as amended by EU Commission Decision 2005/618/EC.

**This product is RoHS Compliant 2005/95/EC.**

“RoHS Compliant 2005/95/EC” means that the product or part (“Product”) does not contain any of the substances in excess of the maximum concentration values in EU Directive 2002/95/EC, as amended by Commission Decision 2005/618/EC, unless the substance is in an application that is exempt under EU RoHS. Unless otherwise stated by 3M in writing, this information represents 3M’s best knowledge and belief based upon information provided by third party suppliers to 3M.

In the event any product is proven not to conform with 3M’s Regulatory Information Appendix, then 3M’s entire liability and Buyer’s exclusive remedy will be in accordance with the Warranty stated below.

#### Appendix E2: European Union RoHS

Directive 2002/95/EC, Restriction of the Use of Certain Hazardous Substances in Electrical & Electronic Equipment, as amended by EU Commission Decision 2005/618/EC.

**This product contains lead in the compliant pin area in excess of the maximum concentration value allowed but is compliant by exemption under EU Commission Decision 2005/747/EC.**

“RoHS Compliant 2005/95/EC” means that the product or part (“Product”) does not contain any of the substances in excess of the maximum concentration values in EU Directive 2002/95/EC, as amended by Commission Decision 2005/618/EC, unless the substance is in an application that is exempt under EU RoHS. Unless otherwise stated by 3M in writing, this information represents 3M’s best knowledge and belief based upon information provided by third party suppliers to 3M.

In the event any product is proven not to conform with 3M’s Regulatory Information Appendix, then 3M’s entire liability and Buyer’s exclusive remedy will be in accordance with the Warranty stated below.

#### Appendix E3: European Union RoHS

Directive 2002/95/EC, Restriction of the Use of Certain Hazardous Substances in Electrical & Electronic Equipment as amended by Commission Decision 2005/618/EC.

**This product contains lead in the solder tail area in excess of the maximum concentration value allowed.**

Unless otherwise stated by 3M in writing, this information represents 3M’s best knowledge and belief based upon information provided by third party suppliers to 3M.

In the event any product is proven not to conform with 3M’s Regulatory Information Appendix, then 3M’s entire liability and Buyer’s exclusive remedy will be in accordance with the Warranty stated below.

#### Appendix E4: European Union RoHS

Directive 2002/95/EC, Restriction of the Use of Certain Hazardous Substances in Electrical & Electronic Equipment, as amended by EU Commission Decision 2005/618/EC.

**This product contains decaBDE in the insulating material in excess of the maximum concentration value allowed but is compliant by exemption under EU Commission Decision 2005/717/EC.**

“RoHS Compliant 2005/95/EC” means that the product or part (“Product”) does not contain any of the substances in excess of the maximum concentration values in EU Directive 2002/95/EC, as amended by Commission Decision 2005/618/EC, unless the substance is in an application that is exempt under EU RoHS. Unless otherwise stated by 3M in writing, this information represents 3M’s best knowledge and belief based upon information provided by third party suppliers to 3M.

In the event any product is proven not to conform with 3M’s Regulatory Information Appendix, then 3M’s entire liability and Buyer’s exclusive remedy will be in accordance with the Warranty stated below.

# Appendix E5: European Union RoHS

Directive 2002/95/EC, Restriction of the Use of Certain Hazardous Substances in Electrical and Electronic Equipment, as amended by EU Commission Decision 2005/618/EC.

**This product contains lead in excess of the maximum concentration value allowed but is compliant by exemption under Item 6 of the Annex to the Directive.**

“RoHS Compliant 2005/95/EC” means that the product or part (“Product”) does not contain any of the substances in excess of the maximum concentration values in EU Directive 2002/95/EC, as amended by Commission Decision 2005/618/EC, unless the substance is in an application that is exempt under EU RoHS. Unless otherwise stated by 3M in writing, this information represents 3M’s best knowledge and belief based upon information provided by third party suppliers to 3M.

In the event any product is proven not to conform with 3M’s Regulatory Information Appendix, then 3M’s entire liability and Buyer’s exclusive remedy will be in accordance with the Warranty stated below.

## CHINA

### Appendix C1: China RoHS



Electronic Industry Standard of the People’s Republic of China, SJ/T11363-2006, Requirements for Concentration Limits for Certain Hazardous Substances in Electronic Information Products.

This symbol, per Marking for the Control of Pollution Caused by Electronic Information Products, SJ/T11364-2006, means that the product or part **does not** contain any of the following substances in excess of the following maximum concentration values in any homogeneous material: (a) 0.1% (by weight) for lead, mercury, hexavalent chromium, polybrominated biphenyls or polybrominated diphenyl ethers; or (b) 0.01% (by weight) for cadmium. Unless otherwise stated by 3M in writing, this information represents 3M’s best knowledge and belief based upon information provided by third party suppliers to 3M.

In the event any product is proven not to conform with 3M’s Regulatory Information Appendix, then 3M’s entire liability and Buyer’s exclusive remedy will be in accordance with the Warranty stated below.

### Appendix C2: China RoHS



Electronic Industry Standard of the People’s Republic of China, SJ/T11363-2006, Requirements for Concentration Limits for Certain Hazardous Substances in Electronic Information Products.

This symbol, per Marking for the Control of Pollution Caused by Electronic Information Products, SJ/T11364-2006, means that the product or part **does** contain a substance, as detailed in the chart below, in excess of the following maximum concentration values in any homogeneous material: (a) 0.1% (by weight) for lead, mercury, hexavalent chromium, polybrominated biphenyls or polybrominated diphenyl ethers; or (b) 0.01% (by weight) for cadmium. Unless otherwise stated by 3M in writing, this information represents 3M’s best knowledge and belief based upon information provided by third party suppliers to 3M.

The numerical reference in the symbol above should not be construed as a representation regarding the product’s life or an extension of a product warranty. The product warranty is stated below. In the event any product is proven not to conform with 3M’s Regulatory Information Appendix, then 3M’s entire liability and Buyer’s exclusive remedy will be in accordance with the product Warranty stated below.

产品中有毒有害物质或元素的名称及含量 Name and Content of Hazardous Substances or Elements

部件名称 (Part or Component Name)	有毒有害物质或元素 (Hazardous Substances or Elements)					
	铅(Pb)	汞(Hg)	镉(Cd)	六价铬(Cr(VI))	多溴联苯(PBB)	多溴二苯醚(PBDE)
端子镀层(contact plating)	×	○	○	○	○	○
○: 表示该有毒有害物质在该部件所有均质材料中的含量均在SJ/T11363-2006 标准规定的限量要求以下。(Indicates that this hazardous substance contained in all of the homogeneous materials for this part is below the limit requirement in SJ/T11363-2006.) ×: 表示该有毒有害物质至少在该部件的某一均质材料中的含量超出SJ/T11363-2006 标准规定的限量要求。(Indicates that this hazardous substance contained in at least one of the homogeneous materials used for this part is above the limit requirement in SJ/T11363-2006.)						

# Appendix C3: China RoHS

Electronic Industry Standard of the People's Republic of China, SJ/T11363-2006, Requirements for Concentration Limits for Certain Hazardous Substances in Electronic Information Products.

This symbol, per Marking for the Control of Pollution Caused by Electronic Information Products, SJ/T11364-2006, means that the product or part **does** contain a substance, as detailed in the chart below, in excess of the following maximum concentration values in any homogeneous material: (a) 0.1% (by weight) for lead, mercury, hexavalent chromium, polybrominated biphenyls or polybrominated diphenyl ethers; or (b) 0.01% (by weight) for cadmium. Unless otherwise stated by 3M in writing, this information represents 3M's best knowledge and belief based upon information provided by third party suppliers to 3M.

The numerical reference in the symbol above should not be construed as a representation regarding the product's life or an extension of a product warranty. The product warranty is stated below. In the event any product is proven not to conform with 3M's Regulatory Information Appendix, then 3M's entire liability and Buyer's exclusive remedy will be in accordance with the product Warranty stated below.

产品中有毒有害物质或元素的名称及含量 Name and Content of Hazardous Substances or Elements

部件名称 (Part or Component Name)	有毒有害物质或元素 (Hazardous Substances or Elements)					
	铅(Pb)	汞(Hg)	镉(Cd)	六价铬(Cr(VI))	多溴联苯(PBB)	多溴二苯醚(PBDE)
合金(Metal alloy)	×	○	○	○	○	○
○：表示该有毒有害物质在该部件所有均质材料中的含量均在SJ/T11363-2006 标准规定的限量要求以下。(Indicates that this hazardous substance contained in all of the homogeneous materials for this part is below the limit requirement in SJ/T11363-2006.) ×：表示该有毒有害物质至少在该部件的某一均质材料中的含量超出SJ/T11363-2006 标准规定的限量要求。(Indicates that this hazardous substance contained in at least one of the homogeneous materials used for this part is above the limit requirement in SJ/T11363-2006.)						

### Important Notice

All statements, technical information, and recommendations related to 3M's products are based on information believed to be reliable, but the accuracy or completeness is not guaranteed. Before using this product, you must evaluate it and determine if it is suitable for your intended application. You assume all risks and liability associated with such use. Any statements related to the product which are not contained in 3M's current publications, or any contrary statements contained on your purchase order shall have no force or effect unless expressly agreed upon, in writing, by an authorized officer of 3M.

### Warranty; Limited Remedy; Limited Liability.

This product will be free from defects in material and manufacture for a period of one (1) year from the time of purchase. **3M MAKES NO OTHER WARRANTIES INCLUDING, BUT NOT LIMITED TO, ANY IMPLIED WARRANTY OF MERCHANTABILITY OR FITNESS FOR A PARTICULAR PURPOSE.** If this product is defective within the warranty period stated above, your exclusive remedy shall be, at 3M's option, to replace or repair the 3M product or refund the purchase price of the 3M product. **Except where prohibited by law, 3M will not be liable for any indirect, special, incidental or consequential loss or damage arising from this 3M product, regardless of the legal theory asserted.**



### 3M Electronics Solutions Division

6801 River Place Blvd.  
Austin, TX 78726-9000  
U.S.A.  
1-800-225-5373  
www.3m.com/interconnects

Please recycle. Printed in USA.  
© 3M 2008. All rights reserved.  
RIA-2217B-D

3M is a trademark of 3M Company.